

C 730 SERIES | 10 kVDC
C 737 SERIES | 15 kVDC
C 720 SERIES | 20 kVDC
C 727 SERIES | 25 kVDC

70,000 FT

-55° TO 95°C

C 735 SERIES | 30 kVDC
C 740 SERIES | 40 kVDC
C 750 SERIES | 50 kVDC

C SERIES

In 1997, Teledyne Reynolds, Inc. acquired the RLA series and other connector product lines from Rowe Industries, Inc. The RLA series has been renamed C series.

C series high voltage lead assemblies and receptacles are widely used in CRT displays, ECM equipment, power supplies, Radar and almost any application where high voltage components need to be interconnected. The plug end is molded onto a desired length of silicone cable and can be ordered single-ended, double-ended or with shielding.

RECEPTACLES

(Dimensions shown as in/mm)

Front Mount

C 730 • 10 kVDC
LGH 1/2I

2RC1505

• **Mounting:** Solder Flange

Sealed, Front Mount

C 737 • 15 kVDC
LGH 1/2LI

2RC1515

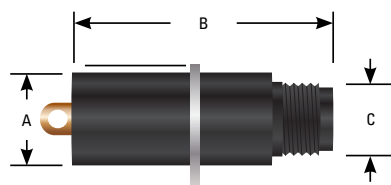

(• = Same value as above)

SERIES	"A"	"B"	"C"
C 730	Ø.380 / 9.65	.620 / 15.7	Ø.570 / 14.4
C 737	•	1.00 / 25.4	Ø.562 / 14.3
C 735	Ø.880 / 22.3	.620 / 15.7	Ø1.12 / 28.4
C 740	Ø.750 / 19.0	1.94 / 49.2	
C 750	Ø1.00 / 25.4	2.12 / 53.8	

C 735 • 30 kVDC
LGH 2I

2RC1545

C 740 • 40 kVDC
LGH 3I

178-6090

C 750 • 50 kVDC
LGH 4I

2RC1565

• **Mounting:** Solder Flange

• **Max. Leak Rate:** 1x10⁻⁶cc/s He @1 ATM differential pressure

In-Line

C 730 • 10 kVDC
LGH 1/2I

3RC1505

C 737 • 15 kVDC
LGH 1/2LI

13RC1515

C 720 • 20 kVDC
LGH LI

3RC1525

C 727 • 25 kVDC
LGH 1LI

RC1535

C 740 • 40 kVDC
LGH 3I

RC1545

C 750 • 50 kVDC
LGH 4I

10RC1565

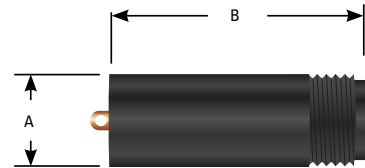

(• = Same value as above)

SERIES	"A"	"B"
C 730	Ø.380 / 9.60	.620 / 15.7
C 737	•	1.00 / 25.4
C 720	Ø.500 / 12.7	•
C 727	Ø.750 / 19.0	1.81 / 45.9
C 740	•	1.94 / 49.2
C 750	Ø1.00 / 25.4	2.12 / 53.8

CABLE ASSEMBLIES

Positive Stop (ferrule)

Single-Ended

C 730 • 10 kVDC
LGH 1/2I

7RC1500

C 737 • 15 kVDC
LGH 1/2LI

7RC1510

C 720 • 20 kVDC
LGH LI

21RC1520

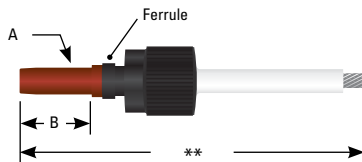

(• = Same value as above)

SERIES	"A"	"B"	WIRE P/N
C 730	Ø.186 / 4.70	.530 / 13.4	178-9863
C 737	Ø.191 / 4.85	.890 / 22.6	178-7200
C 720	Ø.287 / 7.20	•	R790-3516-6

Double-Ended

C 737 • 15 kVDC
LGH 1/2LI

178-7319

• **Uses Wire 178-7200**

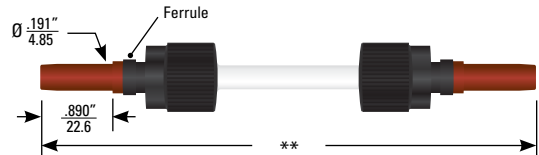

****Cable Assembly Ordering Information:** All cable assembly cable lengths are to be specified in inches only. For example, to order part number 178-6027 with a cable length of 10 feet 8 inches the cable assembly part number would be specified as 178-6027-128N.

• **Note:** Product numbers and specs subject to change without notice. • Products listed represent only a small selection of Teledyne Reynolds' products please visit www.teledynereynolds.com for the most up to date product information. • Contact Teledyne Reynolds' Engineering to discuss custom designs. **WARNING:** Connectors should **NEVER** be handled mated or unmated when voltage is applied. Nomex® is a registered trademark of DuPont.

C 730 SERIES | 10 kVDC
C 737 SERIES | 15 kVDC
C 720 SERIES | 20 kVDC
C 727 SERIES | 25 kVDC

70,000 FT

-55° TO 95°C

C 735 SERIES | 30 kVDC
C 740 SERIES | 40 kVDC
C 750 SERIES | 50 kVDC

CABLE ASSEMBLIES

(Dimensions shown as in/mm)

Non-Positive Stop (washers)

Single-Ended

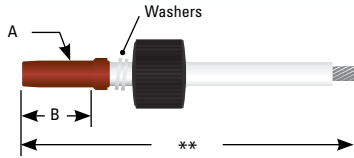

Double-Ended

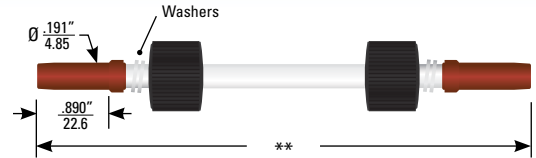

SERIES	VOLTAGE RATING (kVDC)	LGH™ TYPE	SINGLE-ENDED	DOUBLE-ENDED	"A"	"B"	WIRE P/N
C 730	10	LGH 1/2I	RC1500	N/A	Ø.186 / 4.70	.530 / 13.4	R790-3516-6
C 737	15	LGH 1/2LI	RC1510	N/A	Ø.191 / 4.85	.890 / 22.6	•
C 720	20	LGH 1I	RC1520	R1520	Ø.287 / 7.20	•	•
C 727	25	LGH 1LI	RC1530	R1530	•	1.69 / 42.9	178-6147
C 735	30	LGH 2I	RC1540	R1540	•	1.43 / 36.3	•
C 740	40	LGH 3I	RC1550	3R1550	•	1.83 / 45.7	•
C 750	50	LGH 4I	RC1560	3R1560	Ø.435 / 11.0	2.00 / 50.8	178-6181

Single-Ended, Shielded

C 730 • 10 kVDC
LGH 1/2I
2RC1500

C 720 • 20 kVDC
LGH 1I
178-6094

C 727 • 25 kVDC
LGH 1LI
2RC1530

C 750 • 50 kVDC
LGH 4I
2RC1560

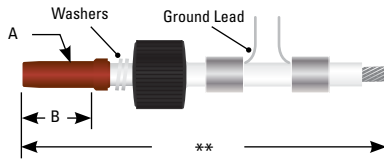

Double-Ended, Shielded

C 730 • 10 kVDC
LGH 1/2I
3R1500

C 737 • 15 kVDC
LGH 1/2LI
2RC1510

C 727 • 25 kVDC
LGH 1LI
2R1530

C 750 • 50 kVDC
LGH 4I
2R1560

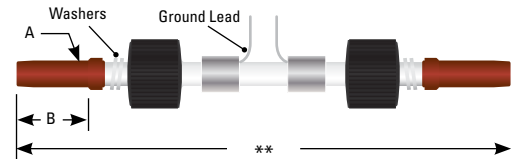

SERIES	"A"	"B"	WIRE P/N	SERIES	"A"	"B"	WIRE P/N
C 730	Ø.186 / 4.70	.530 / 13.4	R790-3516-2	C 730	Ø.186 / 4.70	.530 / 13.4	178-7200
C 720	Ø.287 / 7.0	.880 / 22.6	•	C 737	Ø.191 / 4.85	.890 / 22.6	178-6195-9
C 727	Ø.287 / 7.2	1.69 / 42.9	178-6147	C 727	Ø.287 / 7.20	1.69 / 42.9	178-6147
C 750	Ø.435 / 11.0	2.00 / 50.8	178-6180	C 750	Ø.435 / 11.0	2.00 / 50.8	178-6180

SERIES SPECIFICATIONS

(• = Same value as above)

Series	Voltage Rating (kVDC)	Altitude Rating (ft)	Operating Temp. (°C)	Current Rating (Amp)	Receptacle Insulator Material	Plug Insulator Material	Coupling Style	Coupling Nut Material/Finish	Plug Contact Material/Finish (Socket)	Recept. Contact Material/Finish (Pin)	Wire Type	Wire Insulation	Braid Termination	Test Voltage @ 70,000 ft	Test Voltage @ Sea Level
C 730	10	70,000	-55 to 95	13	Plastic	Silicone	Threaded	Plastic	BeCu/Au with CRES hood	Brass/Tin	Non-Shielded and Shielded	Silicone	N/A	15	N/A
C 737	15	•	•	•	•	•	•	•	•	•	•	•	•	18	•
C 720	20	•	•	•	•	•	•	•	•	•	•	•	•	25	•
C 727	20	•	•	•	•	•	•	•	•	•	•	•	•	35	•
C 735	30	•	•	•	•	•	•	•	•	•	•	•	•	45	•
C 740	40	•	•	•	•	•	•	•	•	•	Non-Shielded	•	•	50	•
C 750	50	•	•	•	•	•	•	•	•	•	Non-Shielded & Shielded	•	•	60	•

WIRE SPECIFICATIONS

Part Number	Operating Voltage (kVDC)	Conductor			Insulation		Shielding			Jacket		Impedance Ω	Attenuation dB/100 ft @ 400mhz	Capacitance pF/FT (Nom.) @ 1k HZ
		AWG	Strands	Plating	Material	σ in./mm	AWG	Plating	σ in./mm	Material	σ in./mm			
178-7200	20	16	41/32	SPC	Silicone	0.165 / 4.19	N/A	N/A	N/A	N/A	N/A	N/A	N/A	N/A
178-6195-9	25	•	26/30	TPC	•	0.266 / 6.76	•	•	•	•	•	•	•	•
178-6147	45	16	19/29	SPC	•	0.300 / 7.62	•	•	•	•	•	•	•	•
178-6181	60	14	19/27	TPC	•	0.390 / 9.91	•	•	•	•	•	•	•	•
178-6180	•	•	•	•	•	•	TPC	TPC	0.430 / 10.9	NOMEX®	0.475 / 12.07	•	•	•

730/830 SERIES		10 kVDC
737 SERIES		15 kVDC
720 SERIES		20 kVDC
727 SERIES		25 kVDC

70,000 FT | -55° TO 125°C

These "7" Series high reliability assemblies, which are intermateable with various LGH™ interfaces, are rated from 10 to 25 kVDC and will operate at altitudes up to 70,000 ft over a temperature range of -55° to 125°C. In comparison to the C Series, this series has improved temperature range capability at altitude operation due to the incorporation of annular sealing rings on the plug insulator.

7 Series plugs are offered in kit form when customers find it necessary to fabricate cable assemblies themselves. Customers should use the Teledyne Reynolds' recommended silicone rubber or silicone coated FEP wire part number that is listed for each plug kit. Fluorosilicone rubber insulators are available for applications where Coolanol® or other fluids that cause silicone rubber to swell may exist.

Plastic bodies are used in the 7 Series plug design to captivate the coupling nut and prevent tearing of silicone insulators from overtorque during mating.

This family of connectors have been widely used Electronic Countermeasure (ECM) Systems • TWT connections • Lasers • Airborne high voltage power supplies

- While plug kits are available for customer-fabricated cable assemblies, Teledyne Reynolds highly recommends purchasing cable assemblies because of difficulties customers may experience in assembly & testing.
- Assembly instructions can be found at www.teledynereynolds.com or by contacting Teledyne Reynolds' Engineering.

PLUG KITS

(Dimensions shown as in/mm)

(• = Same value as above)

730 Series
10 kVDC
LGH 1/2I
• Plastic Coupling Nut

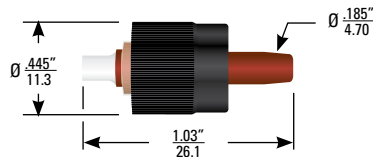

P/N	INSULATOR MATERIAL	WIRE DIA. (in./mm)	WIRE TYPE	WIRE P/N
167-9151	Silicone	Ø.080 / 2.03	FEP	167-9543
167-9274	Fluorosilicone	•	•	•
167-9219	Silicone	Ø.150 / 3.81	Silicone	167-9193

830 Series
10 kVDC
LGH 1/2I
• Metal Coupling Nut

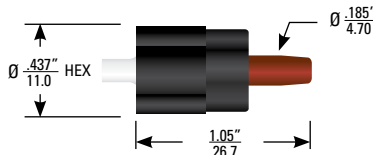

P/N	INSULATOR MATERIAL	WIRE DIA. (in./mm)	WIRE TYPE	WIRE P/N
167-8810	Silicone	Ø.080 / 2.03	FEP	167-9543
167-8782	Fluorosilicone	•	•	•

737 Series
15 kVDC
LGH 1/2LI
• Plastic Coupling Nut

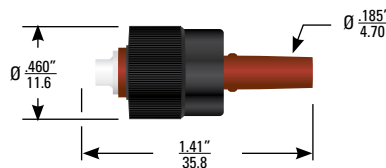

P/N	INSULATOR MATERIAL	WIRE DIA. (in./mm)	WIRE TYPE	WIRE P/N
167-8816	Silicone	Ø.080 / 2.03	FEP	167-9543
167-9391	•	Ø.150 / 3.81	Silicone	167-9193

720 Series
20 kVDC
LGH 1I
• Plastic Coupling Nut

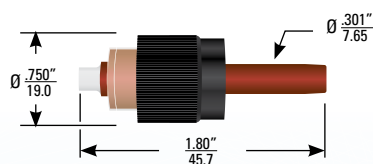

P/N	INSULATOR MATERIAL	WIRE DIA. (in./mm)	WIRE TYPE	WIRE P/N
178-6152	Fluorosilicone	Ø.100 / 2.54	FEP	167-7628
178-6142	Silicone	Ø.110 / 2.79	Silicone Coated FEP	178-8781
167-9296	•	Ø.150 / 3.81	FEP	167-9610
167-9163	•	Ø.180 / 4.57	Silicone	167-9169
167-9149	•	Ø.280 / 7.11	•	167-9180

727 Series
25 kVDC
LGH 1LI
• Plastic Coupling Nut

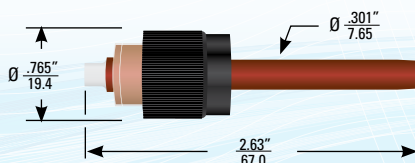

P/N	INSULATOR MATERIAL	WIRE DIA. (in./mm)	WIRE TYPE	WIRE P/N
167-9449	Silicone	Ø.180 / 4.57	FEP	167-9611
167-9330	•	Ø.280 / 7.11	Silicone	167-9180

****Cable Assembly Ordering Information:** All cable assembly cable lengths are to be specified in inches only. For example, to order part number 178-6027 with a cable length of 10 feet 8 inches the cable assembly part number would be specified as 178-6027-128N.

• Note: Product numbers and specs subject to change without notice. • Products listed represent only a small selection of Teledyne Reynolds' products please visit www.teledynereynolds.com for the most up to date product information. • Contact Teledyne Reynolds' Engineering to discuss custom designs. • LGH is a trademark of Tyco Amp, Inc. and Coolanol is a registered trademark of Exxon Mobil Corporation. **WARNING:** Connectors should **NEVER** be handled mated or unmated when voltage is applied.

730/830 SERIES | 10 kVDC
 737 SERIES | 15 kVDC
 720 SERIES | 20 kVDC
 727 SERIES | 25 kVDC

70,000 FT

-55° TO 125°C

RECEPTACLES

(Dimensions shown as in/mm)

Sealed, Front Mount

730/830 • 10 kVDC
LGH 1/2I
 167-9158 - Silicone Seals
 167-9275 - Fluorosilicone Seals

Max. Leak Rate: 1x10⁻⁶ cc/s He @1ATM differential pressure
Panel Mounting Torque: 5 to 6 in-lbs

720 • 20 kVDC
LGH LI

167-9157 - Silicone Seals
 167-9263 - Fluorosilicone Seals

Sealed for 1 ATM differential pressure
Max. Leak Rate: 1x10⁻⁶ cc/s He @1 ATM differential pressure
Panel Mounting Torque: 23 to 28 in-lbs
Mounting: See optional "D" hole

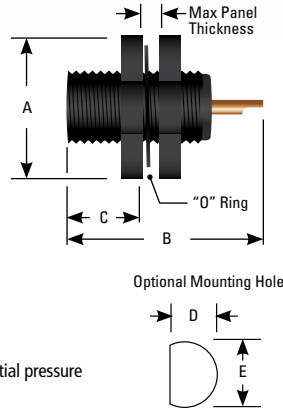

SERIES	"A"	"B"	"C"	MAX PANEL THICKNESS
730/830	.625 / 15.9	.850 / 21.6	.375 / 9.53	.188 / 4.78
720	.960 / 24.4	1.195 / 30.4	.575 / 14.6	.250 / 6.35

Optional Mounting Hole

SERIES	"D"	"E"
730/830	.295 / 7.49	.323 / 8.20
720	.480 / 12.2	.508 / 12.9

Right Angle, Sealed, Front Mount

730/830 • 10 kVDC
LGH 1/2I
 167-9228 - Silicone Seals
 167-9294 - Fluorosilicone Seals

Panel Mounting Torque: 5 to 6 in-lbs

720 • 20 kVDC
LGH LI

167-9227 - Silicone Seals
 167-9293 - Fluorosilicone Seals

Sealed for 1 ATM differential pressure
Max. Leak Rate: 1x10⁻⁶ cc/s He @1 ATM differential pressure
Panel Mounting Torque: 23 to 28 in-lbs
Mounting: See optional "D" hole

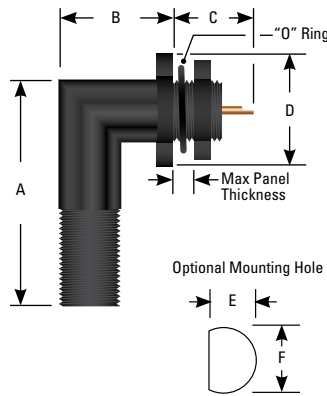

SERIES	"A"	"B"	"C"	"D"	MAX PANEL THICKNESS
730/830	.846 / 21.5	.475 / 12.1	.490 / 12.5	.625 / 15.9	.188 / 4.78
720	1.36 / 34.5	.630 / 17.4	.635 / 16.1	.960 / 24.4	.250 / 6.35

Optional Mounting Hole

SERIES	"E"	"F"
730/830	.295 / 7.49	.323 / 8.20
720	.480 / 12.2	.508 / 12.9

Sealed, Front or Rear Mount

737 • 15 kVDC
LGH 1/2 LI
 167-8721

Sealed for 1 ATM differential pressure
Max. Leak Rate: 1x10⁻⁶ cc/s He @1ATM differential pressure
Panel Mounting Torque: 5 to 6 in-lbs
Mounting: See optional "D" hole

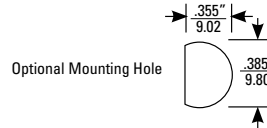
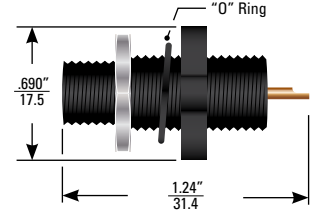

In-Line, Non-Sealed

720 • 20 kVDC
LGH LI

167-8603 - Silicone Seal
 Sealed for 1 ATM differential pressure
Max. Leak Rate: 1x10⁻⁶ cc/s He @1ATM differential pressure
Mounting: See optional "D" hole

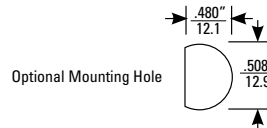
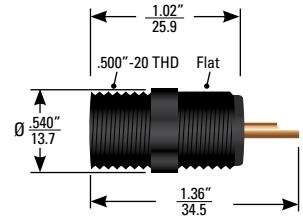

Sealed, Front Mount

727 • 25 kVDC
LGH 1LI

167-9336 - Silicone Seal
 167-9337 - Fluorosilicone Seal
 Sealed for 1 ATM differential pressure
Max. Leak Rate: 1x10⁻⁶ cc/s He @1ATM differential pressure
Mounting: See optional "D" hole

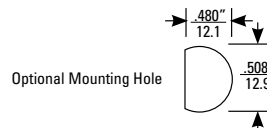
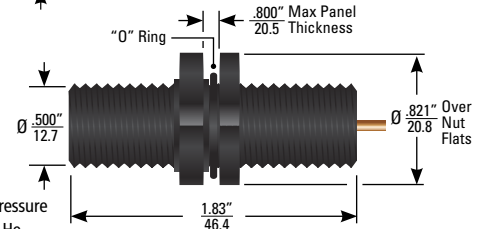

Ceramic-to-Metal, Brazed Hermetic

730/830 • 10 kVDC
LGH 1/2I
 167-8626

720 • 20 kVDC
LGH LI
 167-9803

Sealed for 1 ATM differential pressure
Max. Leak Rate: 1x10⁻⁸ cc/s He @1 ATM differential pressure
Flange material: Iron nickel alloy with nickel plating
Mounting: Solder flange

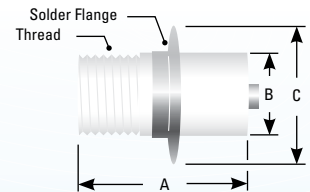

SERIES	THREAD	"A"	"B"	"C"
730/830	312"-32 UNEF-2A	.655 / 16.6	Ø.310 / 7.87	Ø.500 / 12.7
720	.500"-20 UNF-1A	1.03 / 26.0	Ø.498 / 12.7	Ø.812 / 20.6

730/830 SERIES | 10 kVDC
 737 SERIES | 15 kVDC
 720 SERIES | 20 kVDC
 727 SERIES | 25 kVDC

70,000 FT

-55° TO 125°C

CABLE ASSEMBLIES

730

LGH 1/2I

Single-Ended



Double-Ended



(* = Same value as above)

SINGLE-ENDED	DOUBLE-ENDED	WIRE DIA. (in./mm)	WIRE TYPE	WIRE P/N
167-9876	167-9872	.080 / 2.03	FEP	167-9543
167-9879*	167-9875*	.150 / 38.1	Silicone	167-9193
167-9213	167-9210	•	•	•

*Fluorosilicone rubber insulators.

830

LGH 1/2I

Single-Ended



Double-Ended



SINGLE-ENDED	DOUBLE-ENDED	WIRE DIA. (in./mm)	WIRE TYPE	WIRE P/N
167-8812	167-8813	.080 / 2.03	FEP	167-9543
167-8854*	167-8855*	.150 / 38.1	Silicone	167-9193
167-8814	167-8815	•	•	•

*Fluorosilicone rubber insulators.

737

LGH 1/2LI

Single-Ended



Double-Ended

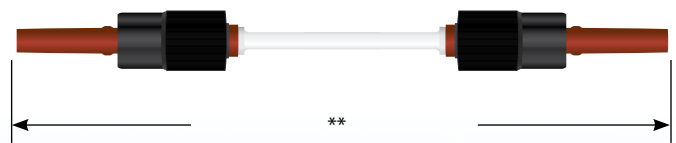

SINGLE-ENDED	DOUBLE-ENDED	WIRE DIA. (in./mm)	WIRE TYPE	WIRE P/N
167-8818	167-8817	.080 / 2.03	FEP	167-9543
167-9917	167-9916	.150 / 38.1	Silicone	167-9193

****Cable Assembly Ordering Information:** All cable assembly cable lengths are to be specified in inches only. For example, to order part number 178-6027 with a cable length of 10 feet 8 inches the cable assembly part number would be specified as 178-6027-128N.

• **Note:** Product numbers and specs subject to change without notice. • Products listed represent only a small selection of Teledyne Reynolds' products please visit www.teledynereynolds.com for the most up to date product information. • Contact Teledyne Reynolds' Engineering to discuss custom designs. **WARNING:** Connectors should **NEVER** be handled mated or unmated when voltage is applied.

730/830 SERIES | 10 kVDC
737 SERIES | 15 kVDC
720 SERIES | 20 kVDC
727 SERIES | 25 kVDC

70,000 FT

-55° TO 125°C

CABLE ASSEMBLIES

720

LGH LI
Single-Ended



Double-Ended

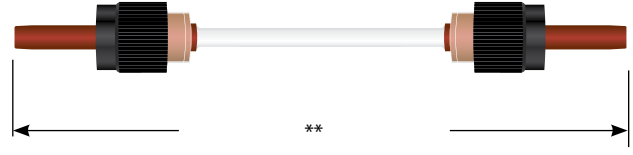

(• = Same value as above)

SINGLE-ENDED	DOUBLE-ENDED	WIRE DIA. (in./mm)	WIRE TYPE	WIRE P/N
178-6154*	178-6153*	.100 / 2.54	FEP	167-7628
178-6144	178-6143	.110 / 2.79	Silicone Coated FEP	178-8781
167-9957	167-8798	.150 / 38.1	FEP	167-9610
167-9164	167-9201	.180 / 4.57	Silicone	167-9169
167-9150	167-9203	.280 / 7.11	•	167-9180

*Fluorosilicone rubber insulators.

727

LGH 1LI
Single-Ended

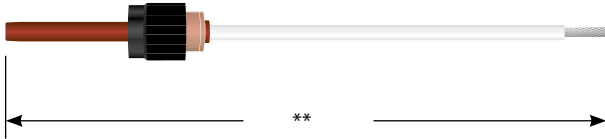

Double-Ended

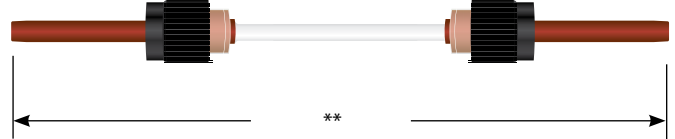

SINGLE-ENDED	DOUBLE-ENDED	WIRE DIA. (in./mm)	WIRE TYPE	WIRE P/N
167-8805	167-8804	.180 / 4.57	FEP	167-9611
167-9332	167-9333	.280 / 7.11	Silicone	167-9180

SERIES SPECIFICATIONS

(• = Same value as above)

Series	Voltage Rating (kVDC)	Altitude Rating (ft)	Operating Temp. (°C)	Current Rating (Amp)	Receptacle Insulator Material	Plug Insulator Material	Coupling Style	Coupling Nut Material/Finish	Plug Contact Material/Finish (Socket)	Recept. Contact Material/Finish (Pin)	Wire Type	Wire Insulation	Braid Termination	Test Voltage @ 70,000 ft	Test Voltage @ Sea Level
730	10	70,000	-55 to 125	13	Plastic or Ceramic	Silicone or Fluorosilicone	Threaded	Plastic	BeCu/Au with CRES hood	Brass/Au or Kovar™	Non-Shielded	FEP or Silicone	N/A	15	N/A
830	•	•	•	•	Plastic	•	•	Al/Anodized	•	Brass/Au	•	•	•	•	•
737	15	•	•	•	•	•	•	Plastic	•	•	•	•	•	18	•
720	20	•	•	•	Plastic or Ceramic	•	•	•	•	Brass/Au or Kovar™	•	•	•	25	•
727	25	•	•	•	Plastic	•	•	•	•	Brass/Au	•	•	•	35	•

WIRE SPECIFICATIONS

Part Number	Operating Voltage (kVDC)	Conductor			Insulation		Shielding			Jacket		Impedance Ω	Attenuation dB/100 ft @ 400mhz	Capacitance pF/FT (Nom.) @1k HZ
		AWG	Strands	Plating	Material	ø in./mm	AWG	Plating	ø in./mm	Material	ø in./mm			
167-9193	17	18	19/30	SPC	Silicone	0.150 / 3.81	N/A	N/A	N/A	N/A	N/A	N/A	N/A	N/A
167-9169	20	16	19/29	•	•	0.180 / 4.57	•	•	•	•	•	•	•	•
167-9180	•	•	19/30	•	•	0.280 / 7.11	•	•	•	•	•	•	•	•
167-9543	22	20	19/32	TPC	FEP	0.080 / 2.03	•	•	•	•	•	•	•	•
167-8781	30	•	•	SPC	Silicone Coated FEP	0.110 / 2.79	•	•	•	•	•	•	•	•
167-9611	•	16	19/29	•	FEP	0.180 / 4.57	•	•	•	•	•	•	•	•
167-7628	•	20	19/32	•	•	0.100 / 2.54	•	•	•	•	•	•	•	•
167-9610	37	•	•	TPC	•	0.150 / 3.81	•	•	•	•	•	•	•	•

Kovar is a registered trademark of the Carpenter Technology Corporation.